

Modular Wiring Solutions

A Complete Pluggable System



CP Electronics
A brand of **legrand**

Hassle-free Modular Wiring Solutions

CP Electronics has been a leading manufacturer of energy saving lighting controls for over 40 years. We understand that market forces within the construction industry present many challenges to designers and installers – none more so in terms of time and cost.

When deadlines are tight and budgets are stretched, we offer a complete pluggable connection solution for your lighting installation, providing quick and easy connection of lighting.

The CP Electronics range of modular wiring products allows any lighting installation to be completed in minimal time using just five key components. These five products are compatible with all of CP Electronics range of Lighting Control Module (LCM) based systems including Vitesse Modular 6, Vitesse Plus and RAPID.

Industry standard connectors

All CP Electronics pluggable products use the series 166 connector format. This ensures compatibility with the luminaire manufacturer who may supply their luminaires with a connector of this type.



Connectors

Our range of connectors are available in both male and female, with black/blue or black/grey coding and with either red or white covers.



Ceiling Rose

Our 6 pole ceiling rose can be used when there is a need to take power and a dimming signal from a conduit box. It has significant termination space.

Luminaire Leads

We provide a full range of luminaire leads. All luminaire connections use the series 166 connector system with a side latch and low profile hood.



Office configuration using modular wiring solutions

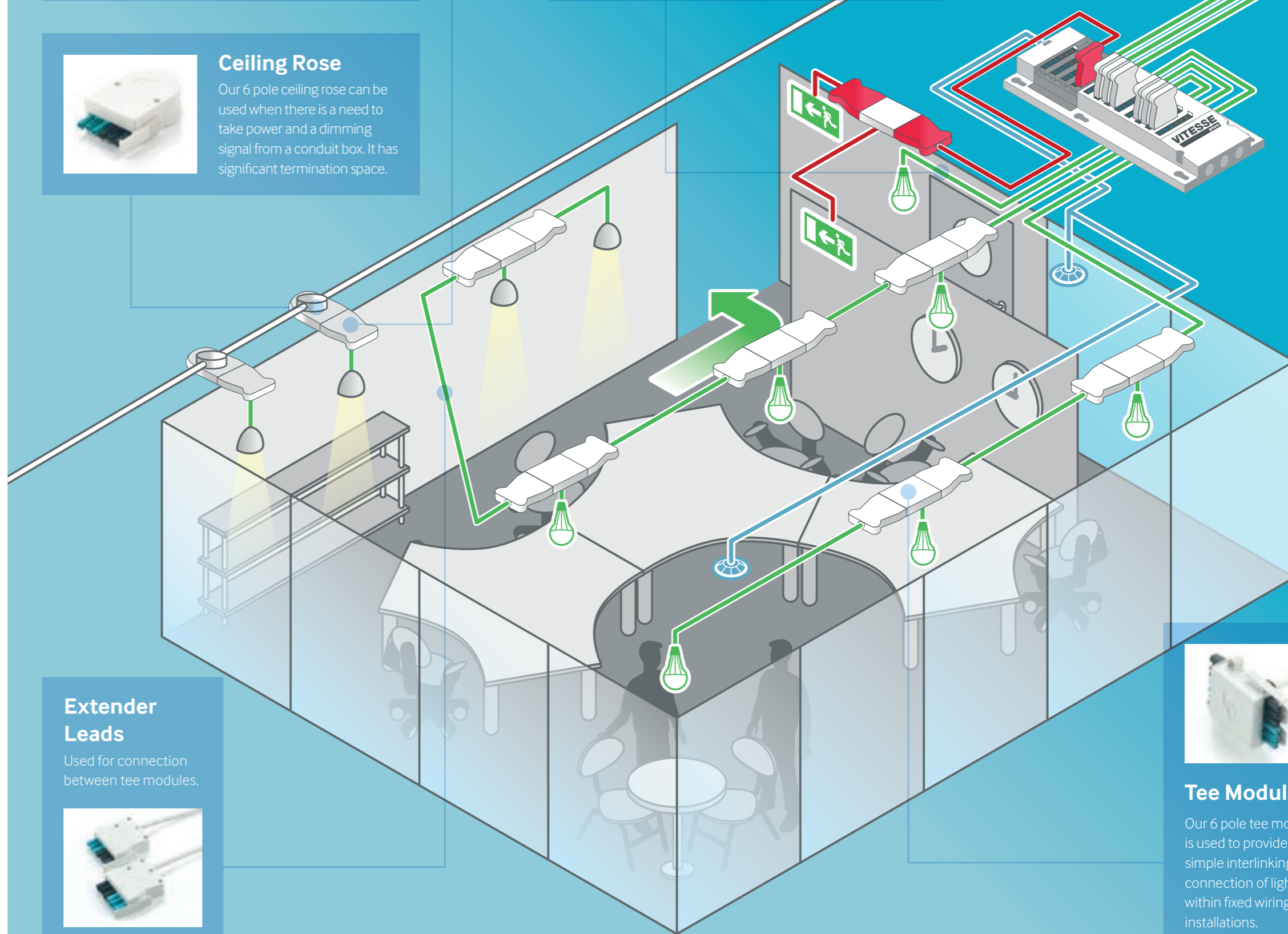

Extender Leads

Used for connection between tee modules.



Tee Modules

Our 6 pole tee module is used to provide a simple interlinking connection of lighting within fixed wiring installations.

Understanding the key components within Modular Wiring

It's important to understand what the main components within a modular wiring system are, and what they do. Once you know, you'll soon realise how quick and easy it is to set up and use.

Male and Female: Know the Difference

One of the first and most important things to understand is the interlocking male and female connectors.

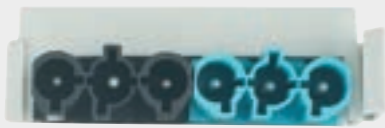

Male Connector

A male connector has solid metal pins. This always receives the power from the corresponding female.



Female Connector

A female connector has split hollow pins. The power is always fed from a female pin (as used on all CP Electronics Lighting Control Modules) as these are fully shrouded to prevent electric shock.

Tee Modules

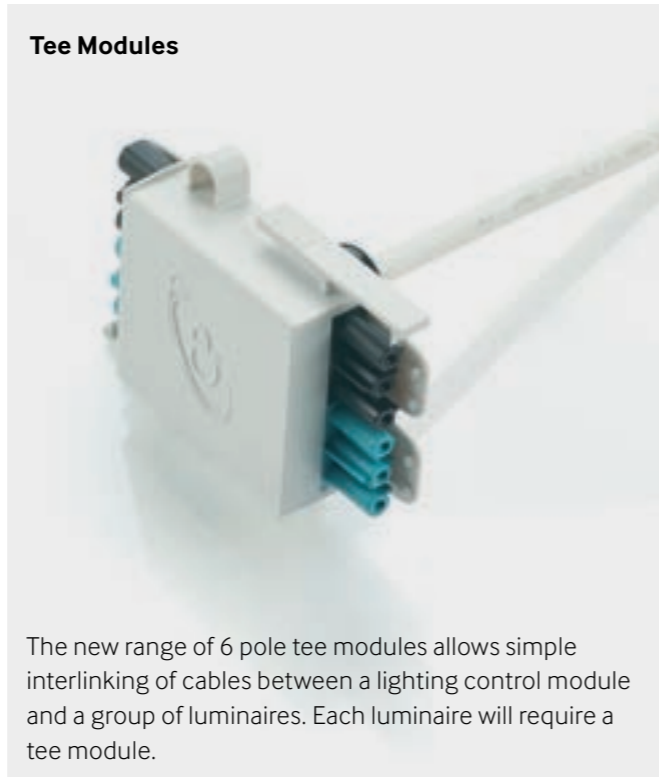

The new range of 6 pole tee modules allows simple interlinking of cables between a lighting control module and a group of luminaires. Each luminaire will require a tee module.

Extender Leads

To link each tee module, an interlink or 'extender lead' is required to fit between the modules.

These can then be installed on cable basket or tray (as shown) or mounted using the fixing tabs on the tee module using suitable cable ties.



System Components

Tee Modules – see page 8



Black/**blue** coding



Black/**grey** coding

Extender Leads – see page 10



White plug, black/**blue** coding



Red plug, black/**blue** coding



White plug, black/**grey** coding



Red plug, black/**grey** coding

Ceiling Roses – see page 11



Black/**blue** coding



Black/**grey** coding

Luminaire Leads – see page 9



White plug, black/**blue** coding



Red plug, black/**blue** coding



White plug, black/**grey** coding



Red plug, black/**grey** coding

Connectors – see page 11



Red plug, black/**blue** coding



White plug, black/**blue** coding









Red plug, black/**grey** coding

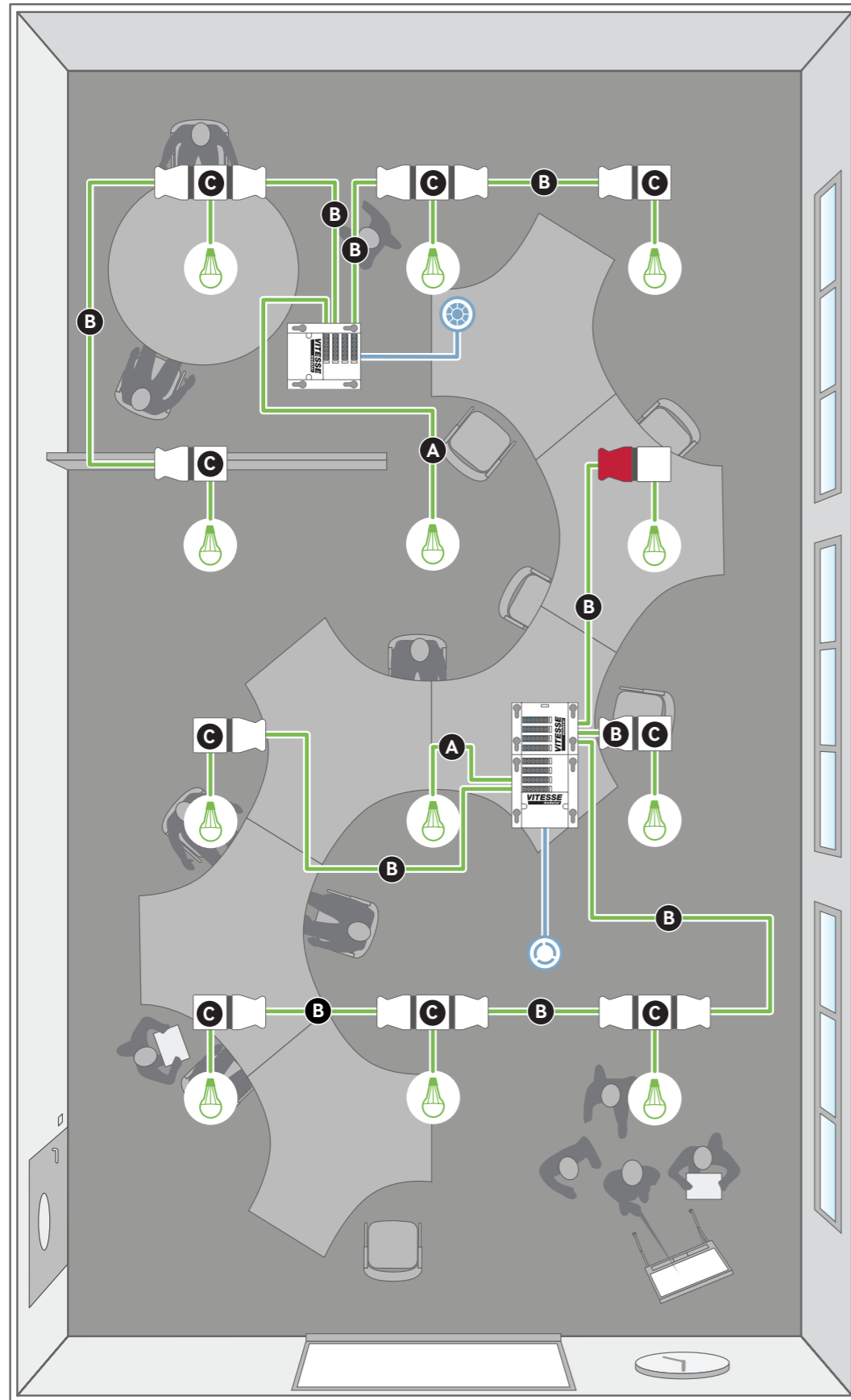

White plug, black/**grey** coding





Office Configuration

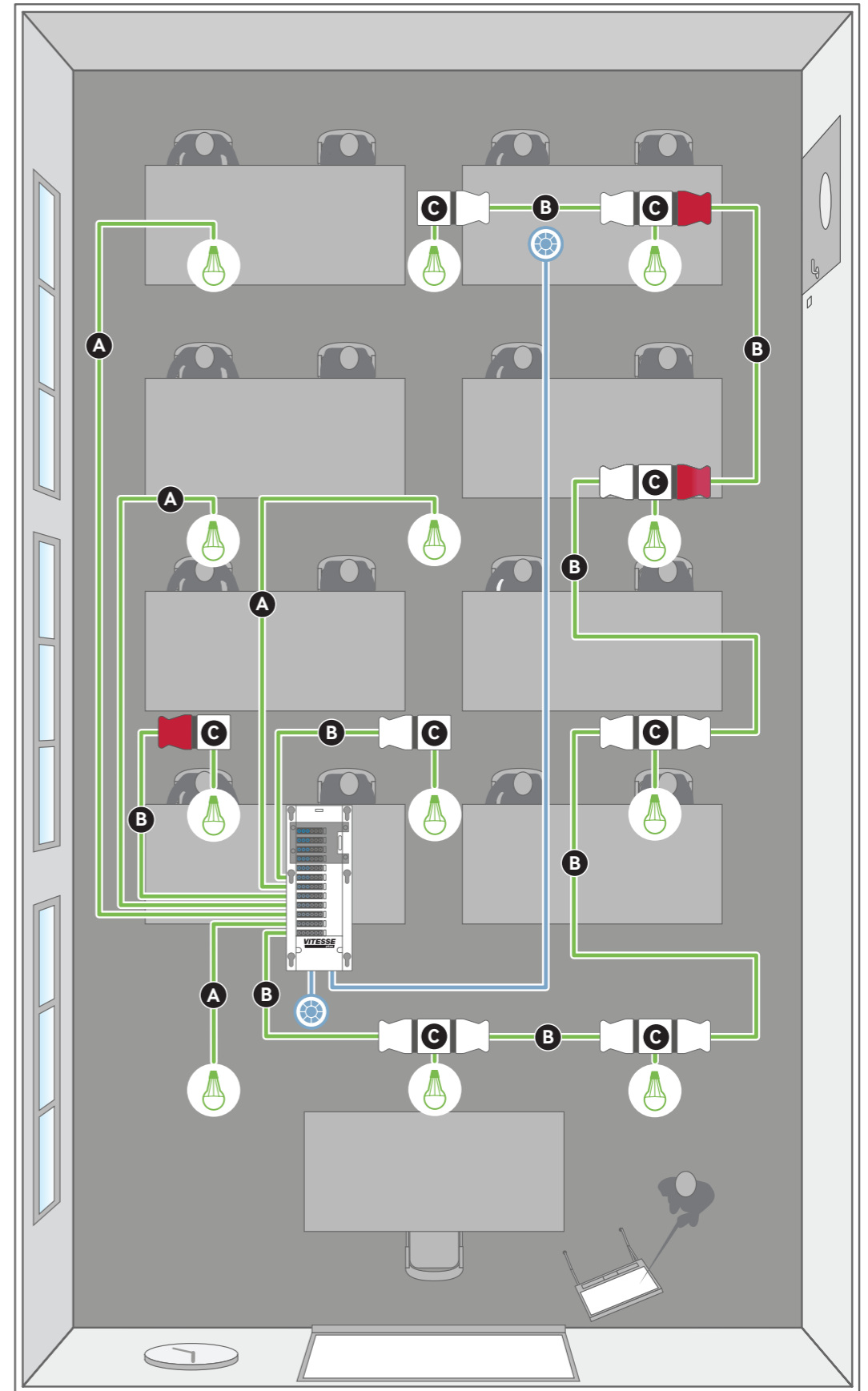

-  Light fittings
-  Presence Detector
-  Microwave Detector
-  Luminaire Leads
-  Extender Leads
-  Tee Modules

Classroom Configuration



-  Light fittings
-  Presence Detector
-  Luminaire Leads
-  Extender Leads
-  Tee Modules

Wiring and Connection Configuration

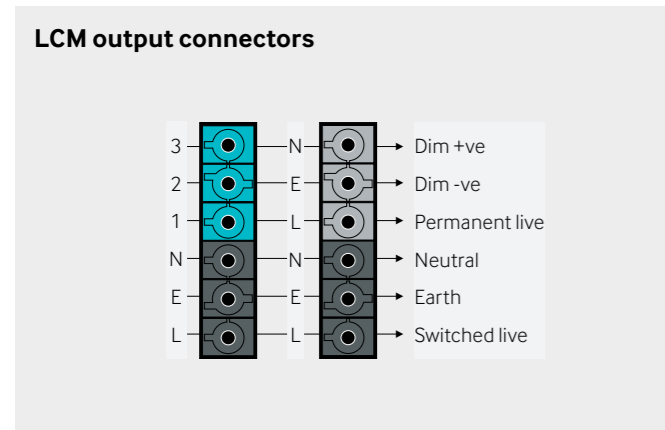

3 core wiring – switching luminaires

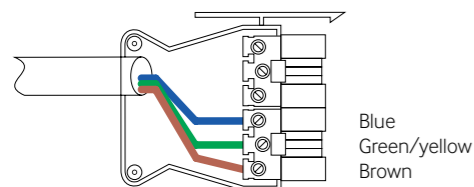

4 core wiring – switching and emergency luminaires

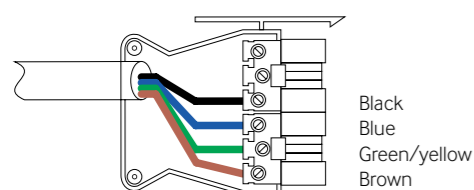

5 core wiring – dimming luminaires

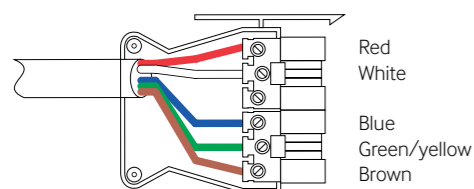

6 core wiring – dimming and emergency luminaires

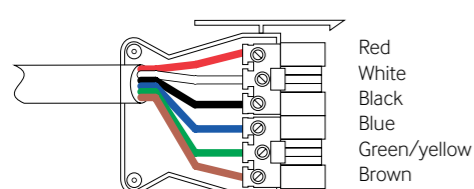

Tee Modules



Black/blue coding

Order Code	Description
BVITM6-L3T500	6 pole, 3 core, 0.5m lead, 1mm ² , tee module, white housing, black/blue coding
BVITM6-L4T500	6 pole, 4 core, 0.5m lead, 1mm ² , tee module, white housing, black/blue coding
BVITM6-L5T500	6 pole, 5 core, 0.5m lead, 1mm ² , tee module, white housing, black/blue coding
BVITM6-L6T500	6 pole, 6 core, 0.5m lead, 1mm ² , tee module, white housing, black/blue coding



Black/grey coding

Order Code	Description
VITM6-L3T500	6 pole, 3 core, 0.5m lead, 1mm ² , tee module, white housing, black/grey coding
VITM6-L4T500	6 pole, 4 core, 0.5m lead, 1mm ² , tee module, white housing, black/grey coding
VITM6-L5T500	6 pole, 5 core, 0.5m lead, 1mm ² , tee module, white housing, black/grey coding
VITM6-L6T500	6 pole, 6 core, 0.5m lead, 1mm ² , tee module, white housing, black/grey coding

Dimensions (mm)

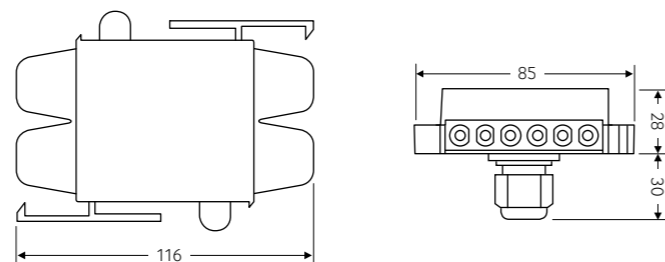

Luminaire Leads

Luminaire leads have a male connector which will connect to an LCM output, ceiling rose or end of line tee module. The free end has a 70mm strip for the inner cores with a 10mm ferrule.

To understand the difference between male and female connectors please see page 4.



Black/blue coding

3 core – switching luminaires

Order Code	Description
BVITM6L303100W	6 pole, 3 core, 3m, 1mm ² , LSF, luminaire lead, white plug, black/blue coding
BVITM6L305100W	6 pole, 3 core, 5m, 1mm ² , LSF, luminaire lead, white plug, black/blue coding
BVITM6L308100W	6 pole, 3 core, 8m, 1mm ² , LSF, luminaire lead, white plug, black/blue coding

4 core – switching and emergency luminaires

Order Code	Description
BVITM6L403100R	6 pole, 4 core, 3m, 1mm ² , LSF, luminaire lead, red plug, black/blue coding
BVITM6L405100R	6 pole, 4 core, 5m, 1mm ² , LSF, luminaire lead, red plug, black/blue coding
BVITM6L408100R	6 pole, 4 core, 8m, 1mm ² , LSF, luminaire lead, red plug, black/blue coding

5 core – dimming luminaires

Order Code	Description
BVITM6L503100W	6 pole, 5 core, 3m, 1mm ² , LSF, luminaire lead, white plug, black/blue coding
BVITM6L505100W	6 pole, 5 core, 5m, 1mm ² , LSF, luminaire lead, white plug, black/blue coding
BVITM6L508100W	6 pole, 5 core, 8m, 1mm ² , LSF, luminaire lead, white plug, black/blue coding

6 core – dimming and emergency luminaires

Order Code	Description
BVITM6L603100R	6 pole, 6 core, 3m, 1mm ² , LSF, luminaire lead, red plug, black/blue coding
BVITM6L605100R	6 pole, 6 core, 5m, 1mm ² , LSF, luminaire lead, red plug, black/blue coding
BVITM6L608100R	6 pole, 6 core, 8m, 1mm ² , LSF, luminaire lead, red plug, black/blue coding

Black/grey coding

3 core – switching luminaires

Order Code	Description
VITM6L303100W	6 pole, 3 core, 3m, 1mm ² , LSF, luminaire lead, white plug, black/grey coding
VITM6L305100W	6 pole, 3 core, 5m, 1mm ² , LSF, luminaire lead, white plug, black/grey coding
VITM6L308100W	6 pole, 3 core, 8m, 1mm ² , LSF, luminaire lead, white plug, black/grey coding

4 core – switching and emergency luminaires

Order Code	Description
VITM6L403100R	6 pole, 4 core, 3m, 1mm ² , LSF, luminaire lead, red plug, black/grey coding
VITM6L405100R	6 pole, 4 core, 5m, 1mm ² , LSF, luminaire lead, red plug, black/grey coding
VITM6L408100R	6 pole, 4 core, 8m, 1mm ² , LSF, luminaire lead, red plug, black/grey coding

5 core – dimming luminaires

Order Code	Description
VITM6L503100W	6 pole, 5 core, 3m, 1mm ² , LSF, luminaire lead, white plug, black/grey coding
VITM6L505100W	6 pole, 5 core, 5m, 1mm ² , LSF, luminaire lead, white plug, black/grey coding
VITM6L508100W	6 pole, 5 core, 8m, 1mm ² , LSF, luminaire lead, white plug, black/grey coding

6 core – dimming and emergency luminaires

Order Code	Description
VITM6L603100R	6 pole, 6 core, 3m, 1mm ² , LSF, luminaire lead, red plug, black/grey coding
VITM6L605100R	6 pole, 6 core, 5m, 1mm ² , LSF, luminaire lead, red plug, black/grey coding
VITM6L608100R	6 pole, 6 core, 8m, 1mm ² , LSF, luminaire lead, red plug, black/grey coding



Extender Leads

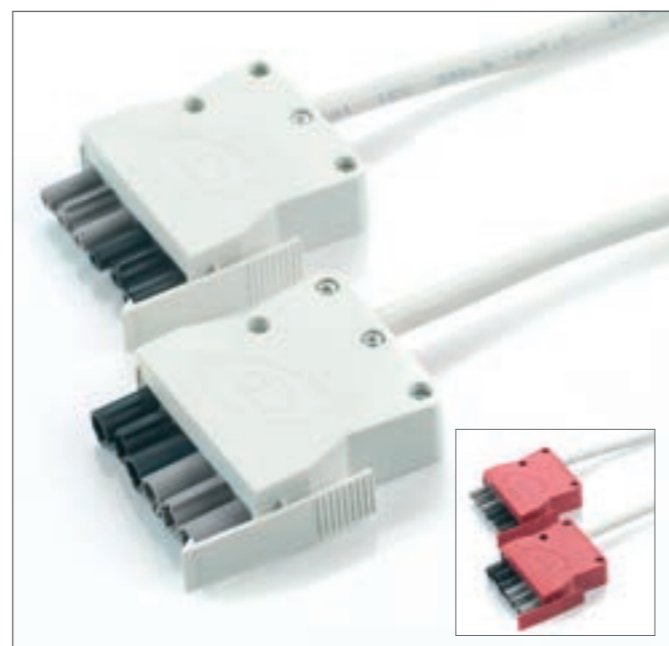

Black/blue coding

3 core – switching luminaires

Order Code	Description
BVITM6-3-LL-03	6 pole, 3 core, 3m, 1.5mm ² , LSF, extender lead, white plug, black/blue coding
BVITM6-3-LL-05	6 pole, 3 core, 5m, 1.5mm ² , LSF, extender lead, white plug, black/blue coding
BVITM6-3-LL-08	6 pole, 3 core, 8m, 1.5mm ² , LSF, extender lead, white plug, black/blue coding

4 core – switching and emergency luminaires

Order Code	Description
BVITM6-4-LL-03	6 pole, 4 core, 3m, 1.5mm ² , LSF, extender lead, red plug, black/blue coding
BVITM6-4-LL-05	6 pole, 4 core, 5m, 1.5mm ² , LSF, extender lead, red plug, black/blue coding
BVITM6-4-LL-08	6 pole, 4 core, 8m, 1.5mm ² , LSF, extender lead, red plug, black/blue coding

5 core – dimming luminaires

Order Code	Description
BVITM6-5-LL-03	6 pole, 5 core, 3m, 1.5mm ² , LSF, extender lead, white plug, black/blue coding
BVITM6-5-LL-05	6 pole, 5 core, 5m, 1.5mm ² , LSF, extender lead, white plug, black/blue coding
BVITM6-5-LL-08	6 pole, 5 core, 8m, 1.5mm ² , LSF, extender lead, white plug, black/blue coding

6 core – dimming and emergency luminaires

Order Code	Description
BVITM6-6-LL-03	6 pole, 6 core, 3m, 1.5mm ² , LSF, extender lead, red plug, black/blue coding
BVITM6-6-LL-05	6 pole, 6 core, 5m, 1.5mm ² , LSF, extender lead, red plug, black/blue coding
BVITM6-6-LL-08	6 pole, 6 core, 8m, 1.5mm ² , LSF, extender lead, red plug, black/blue coding

Black/grey coding

3 core – switching luminaires

Order Code	Description
VITM6-3-LL-03	6 pole, 3 core, 3m, 1.5mm ² , LSF, extender lead, white plug, black/grey coding
VITM6-3-LL-05	6 pole, 3 core, 5m, 1.5mm ² , LSF, extender lead, white plug, black/grey coding
VITM6-3-LL-08	6 pole, 3 core, 8m, 1.5mm ² , LSF, extender lead, white plug, black/grey coding

4 core – switching and emergency luminaires

Order Code	Description
VITM6-4-LL-03	6 pole, 4 core, 3m, 1.5mm ² , LSF, extender lead, red plug, black/grey coding
VITM6-4-LL-05	6 pole, 4 core, 5m, 1.5mm ² , LSF, extender lead, red plug, black/grey coding
VITM6-4-LL-08	6 pole, 4 core, 8m, 1.5mm ² , LSF, extender lead, red plug, black/grey coding

5 core – dimming luminaires

Order Code	Description
VITM6-5-LL-03	6 pole, 5 core, 3m, 1.5mm ² , LSF, extender lead, white plug, black/grey coding
VITM6-5-LL-05	6 pole, 5 core, 5m, 1.5mm ² , LSF, extender lead, white plug, black/grey coding
VITM6-5-LL-08	6 pole, 5 core, 8m, 1.5mm ² , LSF, extender lead, white plug, black/grey coding

6 core – dimming and emergency luminaires

Order Code	Description
VITM6-6-LL-03	6 pole, 6 core, 3m, 1.5mm ² , LSF, extender lead, red plug, black/grey coding
VITM6-6-LL-05	6 pole, 6 core, 5m, 1.5mm ² , LSF, extender lead, red plug, black/grey coding
VITM6-6-LL-08	6 pole, 6 core, 8m, 1.5mm ² , LSF, extender lead, red plug, black/grey coding

Connectors

Using the series 166 connector format CP Electronics range of connectors are available in both male and female, with black/blue or black/grey coding and with either red or white covers. The patented design also allows for rear or side entry, allowing the installer to make up his own leads on site to suit any application.



Black/blue coding

Order Code	Description
BVITM6-LPR	6 pole, male connector, red plug, black/blue coding
BVITM6-LPR-F	6 pole, female connector, red plug, black/blue coding
BVITM6-LPW	6 pole, male connector, white plug, black/blue coding
BVITM6-LPW-F	6 pole, female connector, white plug, black/blue coding

Black/grey coding

Order Code	Description
VITM6-LPR	6 pole, male connector, red plug, black/grey coding
VITM6-LPR-F	6 pole, female connector, red plug, black/grey coding
VITM6-LPW	6 pole, male connector, white plug, black/grey coding
VITM6-LPW-F	6 pole, female connector, white plug, black/grey coding

Ceiling Roses

Available with and without a connector plug.

Black/blue coding

Order Code	Description
VITM6-ROSE-B	6 pole, female ceiling rose, black/blue coding, c/w white male connector plug
VITM6-ROSE-B-R	6 pole, female ceiling rose, black/blue coding, c/w red male connector plug
VITM6-ROSE-B-NP	6 pole, female ceiling rose, black/blue coding, no connector plug

Black/grey coding

Order Code	Description
VITM6-ROSE-G	6 pole, female ceiling rose, black/grey coding c/w white male connector plug
VITM6-ROSE-G-R	6 pole, female ceiling rose, black/grey coding, c/w red male connector plug
VITM6-ROSE-G-NP	6 pole, female ceiling rose, black/grey coding, no connector plug



CP Electronics modular wiring solutions are compatible with:

RAPiD

Fully addressable lighting control system



VITESSE modular

Lighting connection system



VITESSE plus

Stand-alone lighting control system



CP Electronics
A brand of **legrand**

Brent Crescent,
London NW10 7XR, UK

+44 (0)333 900 0671
info@cpelectronics.co.uk
www.cpelectronics.co.uk

connect with us

