

 **Lunatone**

PHASE DIMMER, ACTUATORS & SIGNAL CONVERTERS





PHASE DIMMER, ACTUATORS & SIGNAL CONVERTERS

The following components play a central role in regulating, controlling and adapting signals. Their functions range from modulating electrical waves to converting signals into different

forms, making them crucial building blocks in a variety of applications. This makes it possible to integrate loads without a DALI connection into the DALI system.

TABLE OF CONTENTS		Folder B
DALI-2 PD - DALI 230V phase dimmer	2	DALI RM8 / RM16 2×0-10V - for 2 devices with 0-10V input 7
Relay modules RM8 / RM16	3	wDALI RM8 0/1-10V PWM - wireless relay module with 0/1-10V 7
DALI-2 4Ch PD - 4 channel phase dimmer	4	DALI 0/1-10V - converting DALI to 0-10V, 1-10V or PWM 8
DALI-2 4Ch E-RM - 4 channel electronic relay control	4	DALI Dim2warm - from DT6 commands to two DT6 signals 9
wDALI RM8 - wireless relay module	5	DALI DT8 to DT6 - from DT8-Tc commands to two DT6 signals 9
DALI 4Ch RC - 4 channel relay control	5	1Ch LED Booster/Dimmer 10
DALI Jalousie - 230VAC	6	Overview folder A-E 11
DALI RM8 / RM16 0-10V - relay modules with 0-10V input	6	

DALI-2 PD - DALI 230V phase dimmer

Phase dimmer with DALI control input for integrating 230V retrofit LED lights into a DALI system. DALI PD is available for leading edge, trailing edge or as universal device with automatic load detection.

The DALI-2 PD also supports the operating mode as a DALI controlled electronic switch.



When installing many small LED lights, dimmed by a single DALI PD, the inrush current and power factor must be taken into account.

DALI PD is available as a compact 25W version or in the 300W version.

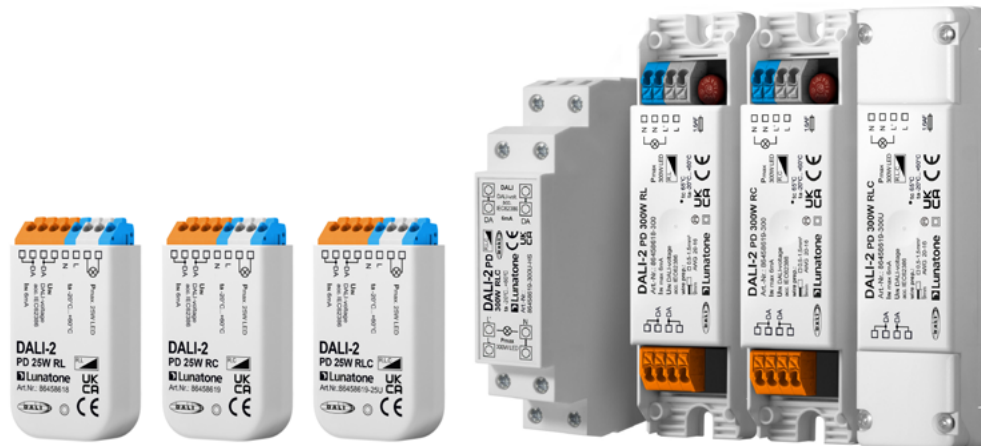

NAME	ARTICLE NUMBER	INPUT	OUTPUT	SUITABLE LOADS	LOAD RANGE	MODEL	DIMENSIONS (MM)
DALI-2 PD 25W universal dimmer	86458619-25U	DALI, 230V AC	230V AC	leading/trailing edge R,L,C	3 - 25W		
DALI-2 PD 25W trailing edge phase cut dimmer	86458619	DALI, 230V AC	230V AC	trailing edge R,C	3 - 25W	for flush-type installation boxes	59 × 33 × 15
DALI-2 PD 25W leading edge phase cut dimmer	86458618	DALI, 230V AC	230V AC	leading edge R,L	3 - 25W		
DALI-2 PD 300W universal dimmer	86458619-300U-HS	DALI, 230V AC	230V AC	leading/trailing edge R,L,C	10 - 300W	for DIN rail	98 × 17,5 × 57
DALI-2 PD 300W universal dimmer	86458619-300U	DALI, 230V AC	230V AC	leading/trailing edge R,L,C	10 - 300W		
DALI-2 PD 300W trailing edge phase cut dimmer	86458619-300	DALI, 230V AC	230V AC	trailing edge R,C	10 - 300W	with strain relief for suspended ceilings	120 × 30 × 22
DALI-2 PD 300W leading edge phase cut dimmer	86458618-300	DALI, 230V AC	230V AC	leading edge R,L	10 - 300W		

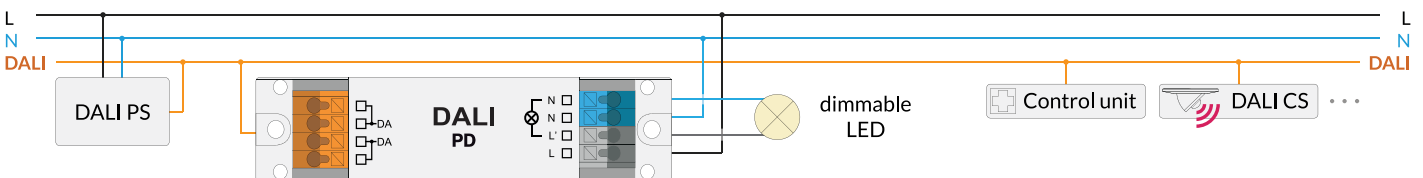

Relay modules RM8 / RM16

The DALI RM8 and DALI RM16 devices provide a relay contact that can be controlled via the DALI bus to switch continuous loads up to 2kW. Various compact designs as well as versions with normally open contacts or changeover contacts are available. Targeted switching in the voltage zero crossing protects the switching contact and increases the device lifetime.

The product range also includes versions with integrated inrush current limitation, these are suitable for applications with very high inrush current peaks.

Power-up mode and system-failure settings can be configured using the DALI Cockpit PC Software.

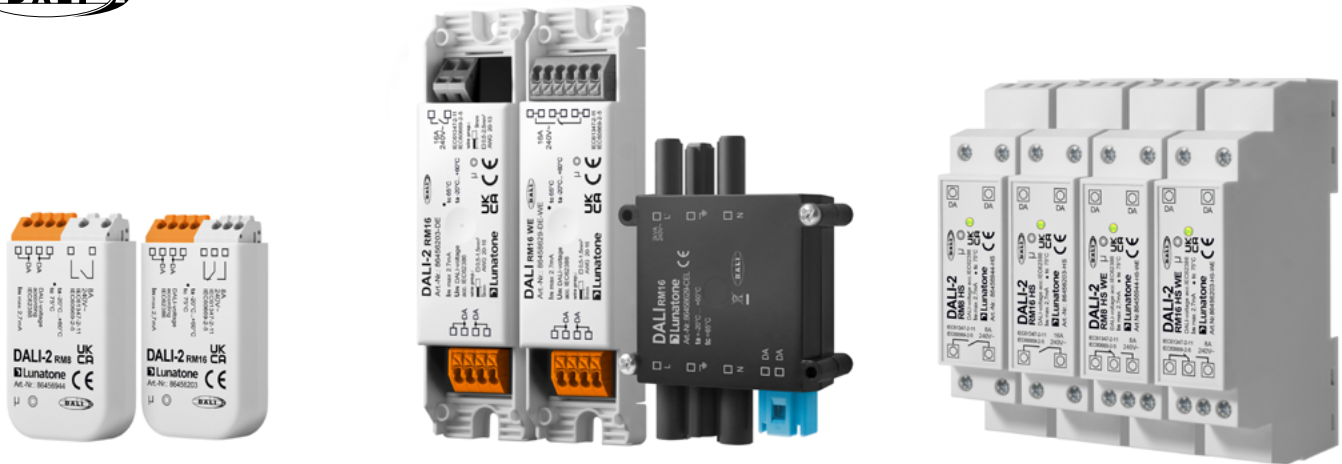

NAME	ARTICLE NUMBER	MAX. NOMINAL LOAD; CIRCUIT BREAKER	MAX. BREAKING CURRENT	MAX. CONTINUOUS CURRENT	TYPE OF RELAY CONTACT	MODEL	DIMENSIONS (MM)
DALI-2 RM8	86456944	1000VA; 6A max	12A	8A	1 normally open	for flush-type installation boxes	59 × 33 × 15
DALI-2 RM16	86456203	1000VA; 6A max	12A	8A	1 changeover		
DALI-2 RM16 DE	86456203-DE	2000VA; 12A max	25A	16A	1 normally open	with strain relief for suspended ceilings	120 × 30 × 22
DALI RM16 DE WE	86458629-DE-WE	2000VA; 12A max	25A	16A	1 changeover		
DALI RM16 Wieland connector	86458629-CEL	2000VA; 12A max	25A	16A	1 normally open	with Wieland connectors	85 × 62 × 18
DALI-2 RM8 DIN rail	86456944-HS	1000VA; 6A max	8A	8A	1 normally open		
DALI-2 RM8 DIN rail WE	86456944-HS-WE	1000VA; 6A max	8A	8A	1 changeover	for DIN rail	98 × 17,5 × 57
DALI-2 RM16 DIN rail	86456203-HS	2000VA; 12A max	16A	16A	1 normally open		
DALI-2 RM16 DIN rail WE	86456203-HS-WE	2000VA; 12A max	16A	8A	1 changeover		

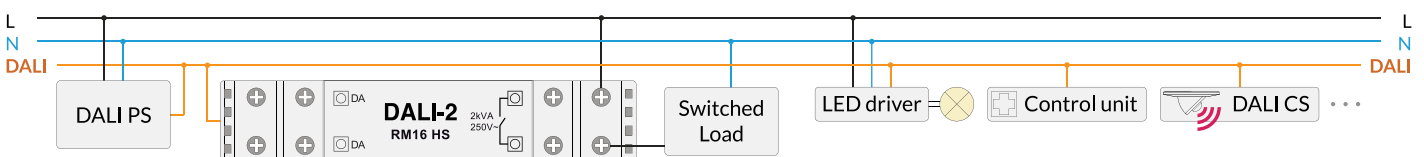

DALI-2 4Ch PD

- 4 channel phase dimmer

Phase dimmer with DALI input to control dimmable 230V luminaires in a DALI system. The 4 channel phase dimmer is suitable for 4x10W loads. Each channel has its own DALI address. Leading edge or trailing edge can be set with the software tool DALI Cockpit. The DALI-2 4Ch PD also supports the operating mode as a DALI controlled electronic switch. The DIN rail housing is suitable for installation in control cabinets.



NAME	ARTICLE NUMBER	INPUT	MAX. CONTROL POWER	NR. OF DALI ADDRESSES	SUITABLE LOADS	OUTPUT VOLTAGE RANGE	MODEL	DIMENSIONS (MM)
DALI-2 4Ch PD	86451975-HS	DALI, 230V AC	4x 10W	4	leading/trailing edge R,L,C	0 to 230VAC	for DIN rail	98 x 17,5 x 57

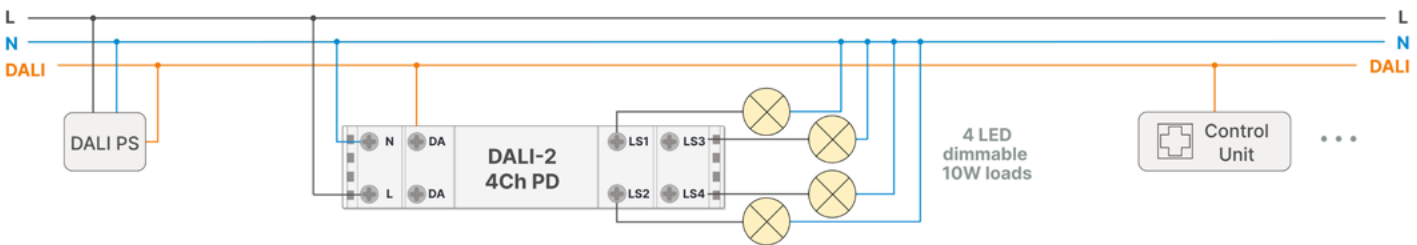

DALI-2 4Ch E-RM

- 4 channel electronic relay control

DALI-2 4Ch E-RM provides 4 switching outputs that can be controlled via the DALI bus (DALI DT7). This means that 230V loads without a DALI input can easily be integrated into a DALI circuit and switched on and off using DALI commands. Each channel has its own DALI address. Power-up mode and system-failure settings can be configured using the software tool DALI Cockpit. The DIN rail housing is suitable for installation in control cabinets.



NAME	ARTICLE NUMBER	INPUT	SWITCHING POWER MAX.	NR. OF DALI ADDRESSES	SWITCHING OUTPUT	OUTPUT VOLTAGE RANGE	MODEL	DIMENSIONS (MM)
DALI-2 4Ch E-RM	86450563-HS	DALI, 230V AC	4x 10W	4	mains voltage	0 to 230VAC	for DIN rail	98 x 17,5 x 57

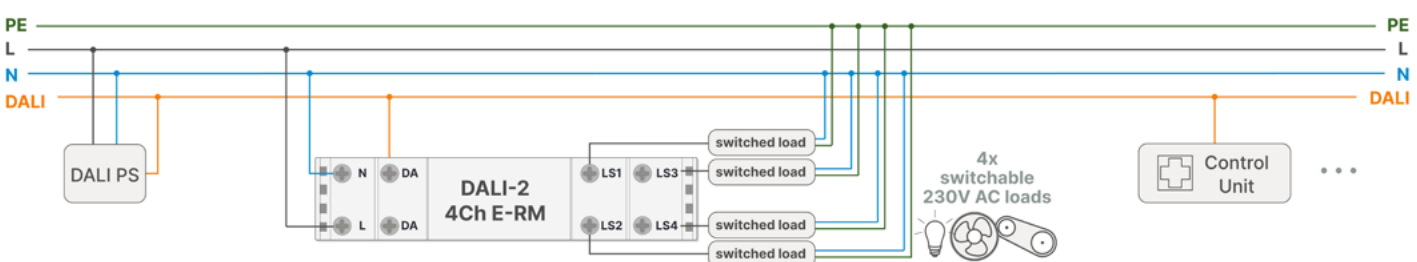

wDALI RM8 - wireless relay module

The wDALI relay module is used to wirelessly control non-dimmable loads. The set consists of a transmitter and a receiver. The transmitter is connected to and powered by the DALI bus (3.8mA). The receiver with relay function is powered by mains voltage. Under optimal conditions the reception range is 300m, in buildings usually 10-20m.



NAME	ARTICLE NUMBER	MAX. NOMINAL LOAD; CIRCUIT BREAKER	MAX. SWITCHING CURRENT	TYPE OF RELAY CONTACT	FREQUENCY RANGE	MODEL	DIMENSIONS (MM)
wDALI RM8 + Transmitter	86459542+TM	1000VA; 6A max	max. 8A	1 on/off	2,4GHz	for flush-type installation boxes	59 × 33 × 15

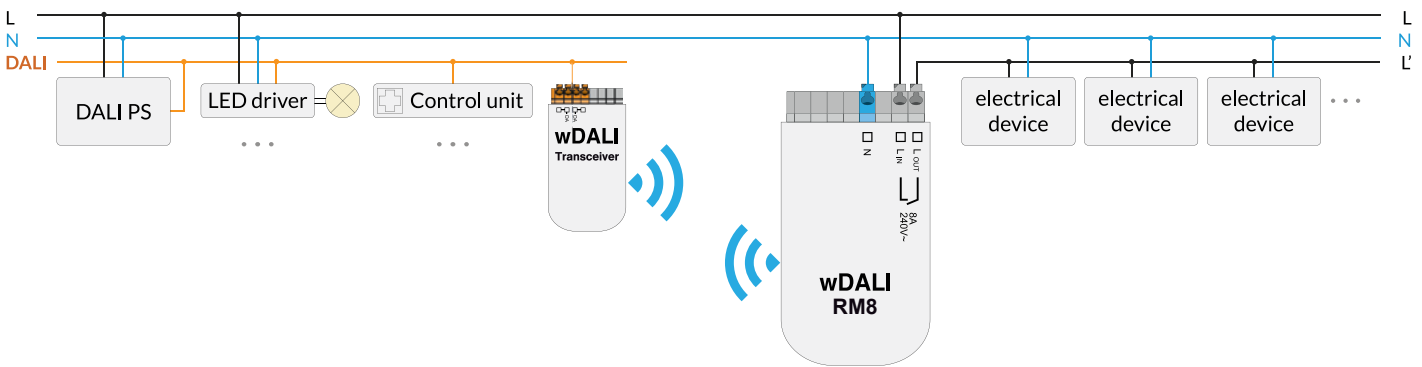

DALI 4Ch RC - 4 channel relay control

DALI relay controller with 4 channels. Each channel has its own DALI address. Designed for controlling relays and contactors with 12V to 48V DC control input. Different versions suitable for DIN rail mounting or remote ceiling installation (housing with strain relief) are available.



NAME	ARTICLE NUMBER	INPUT VOLTAGE	MAX. INPUT CURRENT	NR. OF DALI ADDRESSES	OUTPUT CURRENT PER CHANNEL	MODEL	DIMENSIONS (MM)
DALI-2 4Ch RC DIN rail	89453860-HS	12-48V DC	max. 8A	4	max. 2A	for DIN rail	98 × 17,5 × 57
DALI-2 4Ch RC	89453860-DE	12-48V DC	max. 8A	4	max. 2A	with strain relief for suspended ceilings	120 × 30 × 22

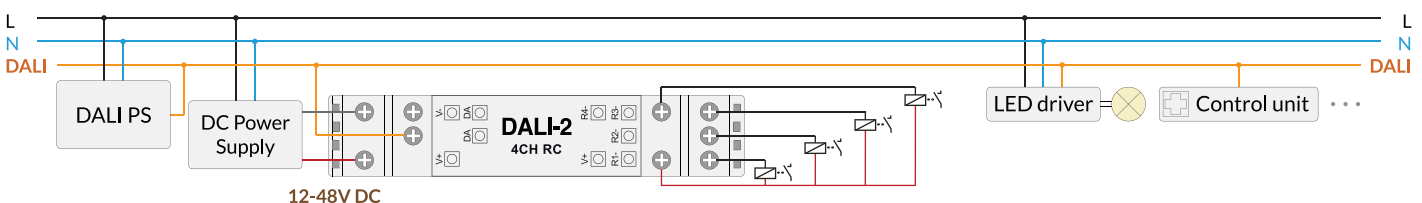

DALI Jalousie - 230VAC

The DALI Jalousie module can be used to control blind motors with 230V control input via DALI. Four configurable profiles can be programmed to open/close the blinds and to change the tilt angle. Different versions suitable for DIN rail mounting or remote ceiling installation (housing with strain relief) are available.



NAME	ARTICLE NUMBER	SUPPLY	TYP. DALI CURRENT CONSUMPTION	OPERATING TEMPERATURE (TA)	MODEL	DIMENSIONS (MM)
DALI Jalousie DIN rail	86458676-HS	via DALI line	5,5mA	-20°C ... +60°C	for DIN rail	98 × 17,5 × 57
DALI Jalousie	86458676-DE	via DALI line	5,5mA	-20°C ... +60°C	with strain relief for suspended ceilings	120 × 30 × 22

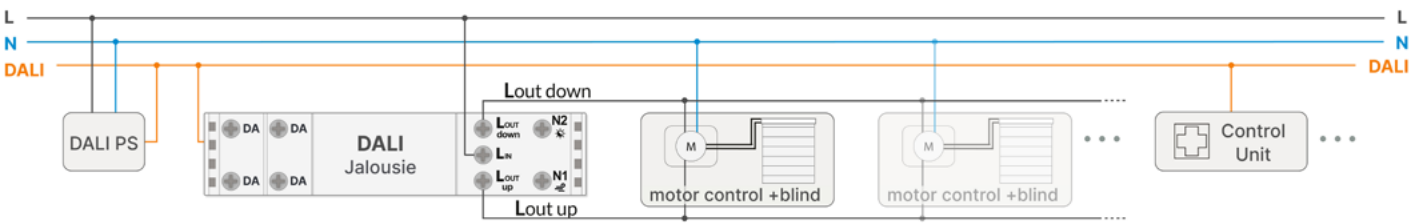

DALI RM8 / RM16 0-10V - relay modules with 0-10V control input

0-10V interface with 8A or 16A relay. This interface converts DALI signals into 1-10V control signals and thus enables the integration of devices with 1-10V control input into a DALI system. With the integrated switching relay, the power supply of the operating devices can be switched on and off. The modules are compliant with DALI Device Type 5 (IEC62386-206). The Linear or logarithmic dimming curve as well as the 0-10V or 1-10V control voltage range are adjustable via the DALI Cockpit software. The devices with PWM (see table) can also control operating devices with PWM input. The DALI input is galvanically isolated from the PWM/1-10V output.



NAME	ARTICLE NUMBER	SWITCHING CURRENT RELAY CONTACT	TYPE OF RELAY CONTACT	OUTPUT (0-10V)	MODEL	DIMENSIONS (MM)
DALI RM8 PWM	86458668	max. 8A	1 on/off	0-100% PWM (14Bit, 488Hz), current sink 2mA	for flush-type installation boxes	59 x 33 x 15
DALI RM8 1-10V AN	86458668-AN	max. 8A	1 on/off	1-10V analog, current sink 1mA	for flush-type installation boxes	59 x 33 x 15
DALI RM16 1-10V with Wieland connectors	86458936	max. 16A	1 on/off	0-100% PWM (14Bit, 488Hz), current sink 2mA	with Wieland connectors	85 x 22 x 60
DALI RM16 0-10V PWM DE	86458667-DE	max. 16A	1 on/off	0-100% PWM (14Bit, 488Hz), current sink 2mA	with strain relief for suspended ceilings	120 x 30 x 22

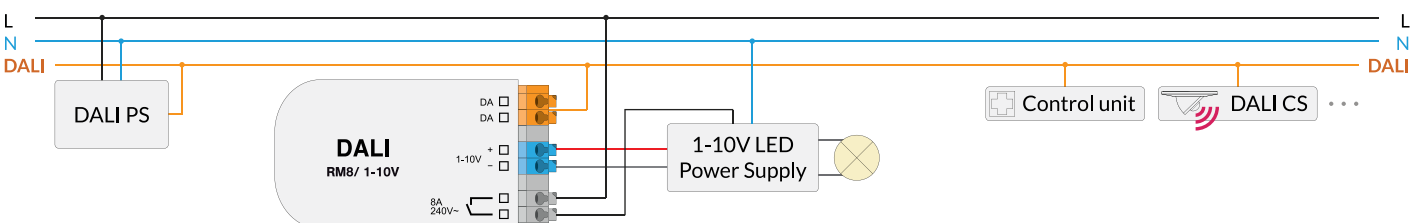

DALI RM8 / RM16 2x0-10V - operating 2 devices with 0-10V control input

This interface converts DALI signals into a 1-10V control signal and allows the integration of operating devices with two 1-10V control inputs for brightness and colour temperature into a DALI system. Output mode for channel1 / channel2 can be defined as either Brightness/Tc or separate channels for CW and WW.



NAME	ARTICLE NUMBER	SWITCHING CURRENT RELAY CONTACT	TYPE OF RELAY CONTACT	OUTPUT (1-10V)	MODEL	DIMENSIONS (MM)
DALI RM16 2x0-10V DIN rail	89453857-HS	max. 16A	1 on/off	channel 1: 1-10V analog, current sink 1mA	for DIN rail	98 x 17,5 x 57
DALI RM16 2x0-10V DE	89453857-DE	max. 8A	1 on/off	channel 2: 1-10V analog, current sink 1mA	with strain relief for suspended ceilings	120 x 30 x 22

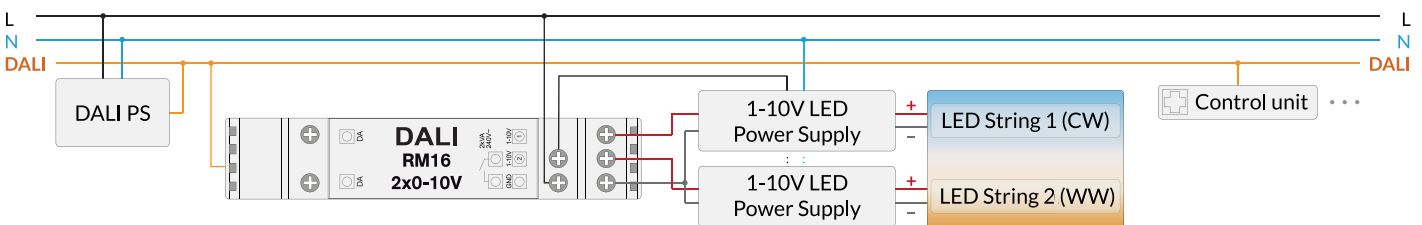

wDALI RM8 0/1-10V PWM - wireless relay module with 0/1-10V PWM control output

Wireless 0-10V PWM interface with integrated 8A relay. The set consists of a transmitter and a receiver and is used to wirelessly control lights with 0-10V / 1-10V / PWM operating devices.

The transmitter is connected to and powered by the DALI bus (3.8mA). The receiver has a 0-10V PWM output and a relay function and is powered by mains voltage.

The wDALI RM8 0-10V enables the wireless integration of electrical devices such as floor lamps and outdoor lighting into a DALI system. Under optimal conditions the reception range is 300m, in buildings usually 10-20m.



NAME	ARTICLE NUMBER	SWITCHING CURRENT RELAY CONTACT	TYPE OF RELAY CONTACT	OUTPUT (0-10V)	MODEL	DIMENSIONS (MM)
wDALI RM8 0-10V PWM + Transmitter	89453852+T	max. 8A	1 on/off	0-100% PWM (16Bit, 488Hz), current sink 1mA	for flush-type installation boxes	59 x 33 x 15

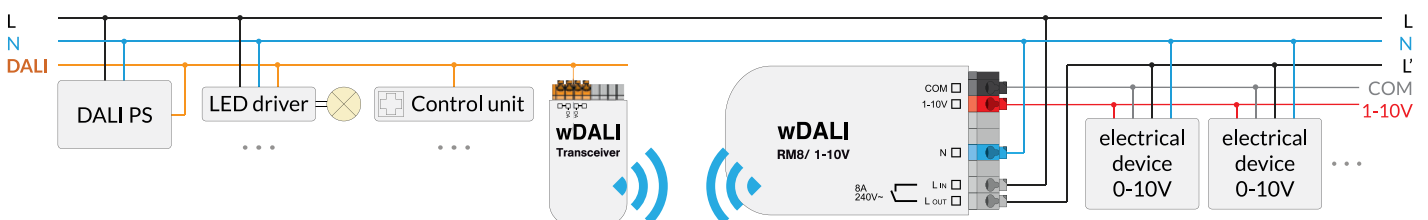

DALI 0/1-10V - converting DALI to 0-10V, 1-10V or PWM

These interfaces convert DALI signals into 0-10V, 1-10V or PWM control signals, thus enabling the integration of electrical devices with 0-10V control inputs into a DALI system, options listed in table below.

A single module can control up to 10 ballasts. The output voltage range as well as linear or logarithmic dimming curve can be adjusted via the DALI Cockpit Software.



NAME	ARTICLE NUMBER	SIGNAL	SIGNAL RANGE	I/O SIGNAL	GALVANIC ISOLATION	MODEL	DIMENSIONS (MM)
DALI 0-10V LE	86458508-LE	analog	0 - 10V	current sink: max. 1mA	no	for flush-type installation boxes	40 x 28 x 15
DALI 0-10V AN	86458508-AN	analog	0,6 - 10V	current sink: 100uA-1mA	yes	for flush-type installation boxes	40 x 28 x 15
DALI 0-10V PWM	86458508-PWM	PWM digital	0 - 100% PWM frequency fixed 488Hz	switching current: max. 1mA voltage: max. 10V	yes	for flush-type installation boxes	40 x 28 x 15
DALI PWM 100mA	86458508-100	PWM digital	0 - 100% PWM frequency adjustable: 488Hz / 976Hz	switching current: max. 100mA voltage: max 60VDC	yes	for flush-type installation boxes	40 x 28 x 15

86458508-LE enables the integration of devices that have an integrated galvanic isolation and a 0-10V or 1-10V control input:

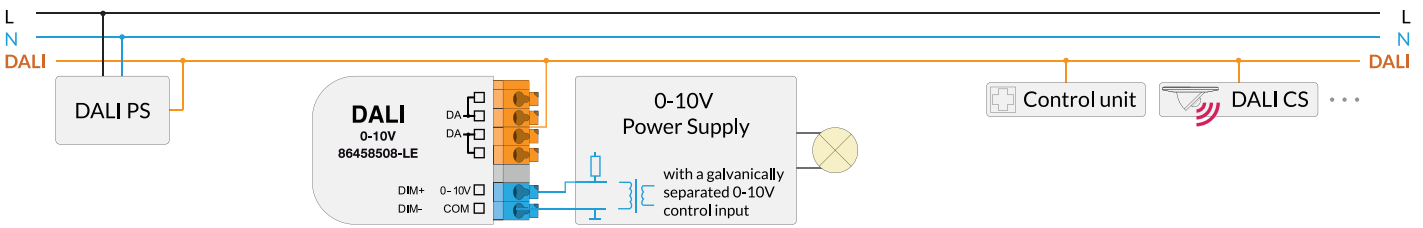

86458508-AN offers a galvanically isolated output and enables the integration of devices with 0-10V or 1-10V control input:

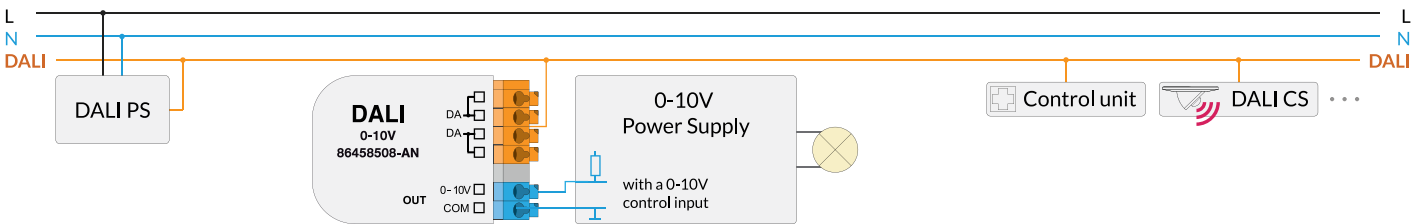

86458508-PWM offers a galvanically isolated output and enables the integration of devices with a PWM control input:

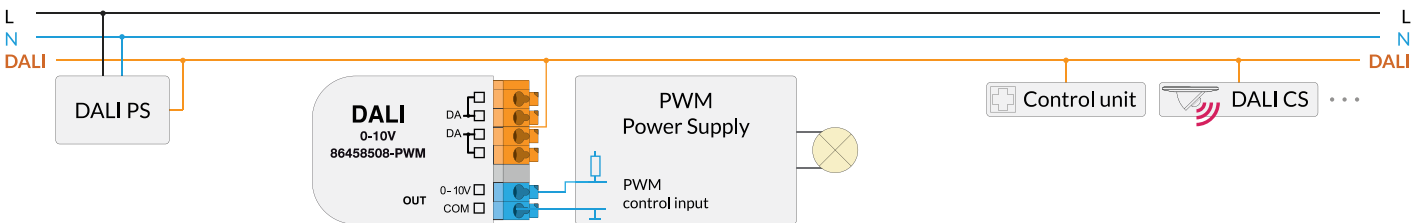

86458508-100 offers a galvanically isolated output and enables the integration of up to 100 devices with PWM control input:

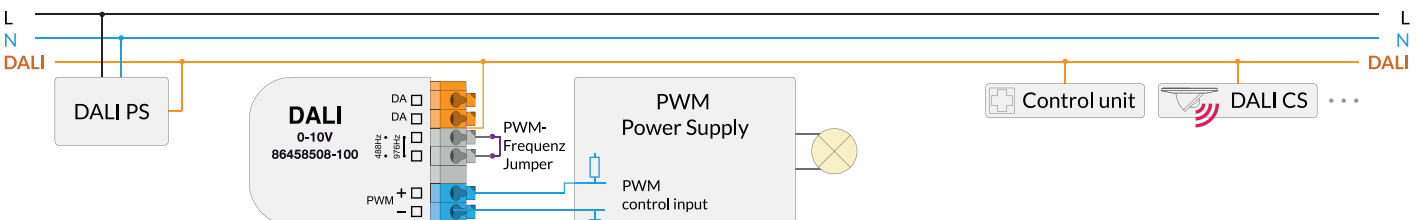

DALI Dim2warm - converting DT6 dimming commands into two DT6 control signals

With only one DT6 DALI address, the Dim2Warm module allows the simultaneous control of brightness while changing the colour temperature. The lower the dimming value, the warmer the light. The output curves of the two channels can be individually adjusted via the DALI Cockpit. This device can also be used for direct and indirect lighting with just one DALI address.



NAME	ARTICLE NUMBER	CURRENT CONSUMPTION DALI	OUTPUT	OPERATING TEMPERATURE (TA)	DIMENSIONS (MM)
DALI Dim2warm	89453864	4.5mA + current consumption subnet	2xDALI	-20°C ... +60°C	40 × 28 × 15

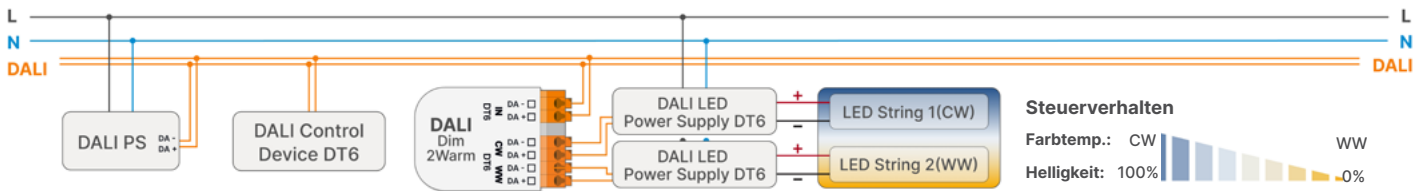

DALI DT8 to DT6 - converting DT8-Tc commands into two DT6 control signals

DALI interface module for converting DT8-Tc control commands into DT6 control signals. The module allows dimming and adjustment of colour temperature via DT8 commands. Also suitable for lights with two DALI DT6 operating devices. Factory setting: separate outputs for cold-white and warm-white channel.



NAME	ARTICLE NUMBER	CURRENT CONSUMPTION DALI	OUTPUT	OPERATING TEMPERATURE (TA)	DIMENSIONS (MM)
DALI DT8 to DT6	89453859	4.5mA + current consumption subnet	2xDALI	-20°C ... +60°C	40 × 28 × 15

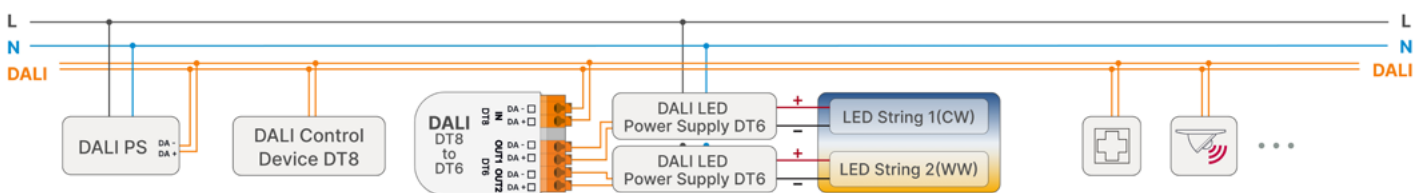

1Ch LED Booster/Dimmer

LED driver (CV) with one channel, can operate as PWM Booster or Dimmer.

The device operates as PWM-Booster, if PWM-signals are applied to the input (50Hz-1kHz).

If operated with 100kΩ potentiometer or 0-10V control device (active and passive), the device functions as Dimmer.



NAME	ARTICLE NUMBER	CONTROL INPUT	MAX. INPUT CURRENT	SUPPLY	DIMENSIONS (MM)
1CH LED Booster/ Dimmer CV 16A	86459838	- PWM (50Hz-1kHz) - 100kOhm potentiometer - 0-10V active/passive	16A	12-48V DC	120 × 30 × 22

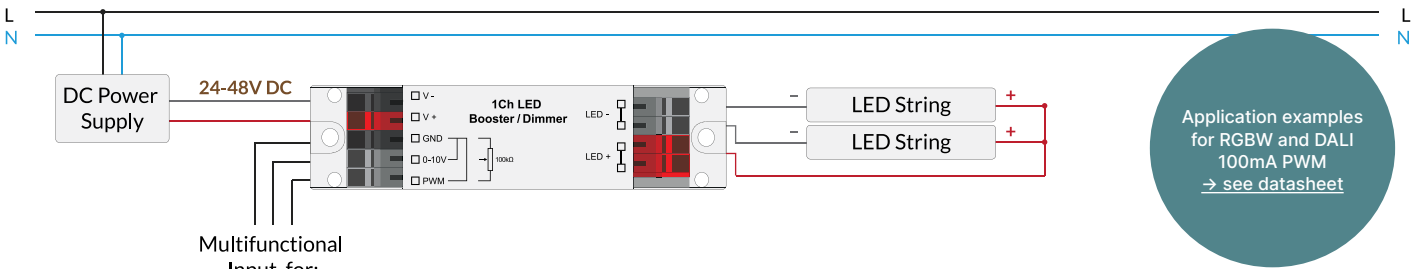

Application examples for RGBW and DALI 100mA PWM → see datasheet

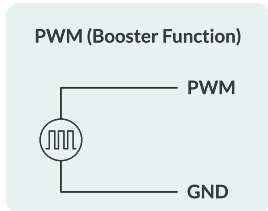
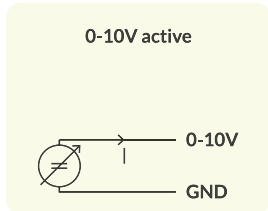
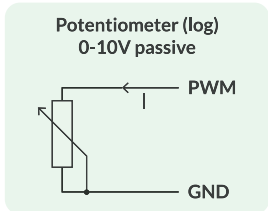
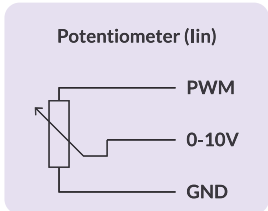

OVERVIEW FOLDER A-E

INPUT DEVICES, CONTROL UNITS & SENSORS

[→ open Folder A](#)

DALI-2 Display 4" and 7"	2	wDALI Switch Cross	18	DALI CDC - time based CW-WW control	27
DALI-2 Display 7" – Emergency	4	wDALI Remote	19	DALI-2 RTC+ Timer	28
DALI-2 Display Bus Extension	5	wDALI MC - wireless pushbutton coupler	20	DALI NFC App - settings configuration	28
DALI-2 Touchpanel	6	DALI-2 MC - pushbutton coupler	20	DALI Daylight Bluetooth Interface	29
DALI Touchpanel	8	DALI-2 MC1L - pushbutton coupler	21	DALI-2 Audio Interface	29
DALI Bluetooth Interface	8	DALI-2 MC4L - pushbutton coupler	22	DALI-2 CS	30
DALI Touchpanel Bluetooth 4.0	9	DALI-2 MC1L PS, MC2L PS	22	DALI-2 CS Integration THP LE	34
DALI-2 KNX Room Controller	10	DALI-2 MC4L POTI - pushbutton coupler	23	DALI-2 CS Mini	35
DALI-2 Room Controller	10	DALI 100K - interface for potentiometer	23	DALI-2 CS Corridor	36
DALI Cockpit Mobile - smartphone app	11	EnOcean DALI-2 MC	24	DALI CS with 20mA DALI power supply	37
DALI ROT	12	DALI GC(-A) - controlling 2 DALI groups	24	DALI SI, SI-1L	37
DALI-2 ROT	14	DALI SC(-A) - controlling 4 DALI scenes	25	DALI-2 LS - light sensor	38
DALI-2 ROT Touch	16	DALI LR PS 20mA - auto. reduction	25	DALI Temp - temperature sensor	38
DALI-2 Switch Cross NFC	17	DALI-2 Sequencer	26		

PHASE DIMMER, ACTUATORS & SIGNAL CONVERTERS

[→ open Folder B](#)

DALI-2 PD - DALI 230V phase dimmer	2	DALI Jalousie - 230VAC	6	module with 0/1-10V	7
Relay modules RM8 / RM16	3	DALI RM8 / RM16 0-10V - relay modules with	6	DALI 0/1-10V - converting DALI to 0-10V,	8
DALI-2 4Ch PD - 4 channel phase dimmer	4	0-10V input	6	1-10V or PWM	8
DALI-2 4Ch E-RM - 4 channel relay control	4	DALI RM8 / RM16 2×0-10V - for 2 devices	7	DALI Dim2warm - from DT6 to 2x DT6	9
wDALI RM8 - wireless relay module	5	with 0-10V input	7	DALI DT8 to DT6 - from DT8-Tc to 2x DT6	9
DALI 4Ch RC - 4 channel relay control	5	wDALI RM8 0/1-10V PWM - wireless relay	7	1Ch LED Booster/Dimmer	10

OPERATING DEVICES 230VAC / 48V / 24V

[→ open Folder C](#)

1-4 Channels, Constant Voltage (CV)	4	CW-WW, RGB, RGBW - Constant Current	9	230V Operating Devices - DALI LED Power	12
1-4 Channels, Constant Current (CC)	6	230V Operating Devices - DALI LED Power	11	Supply - Tunable White DT8, CV-CC	12
CW-WW, RGB, RGBW - Constant Voltage	8	Supply - 1 Channel DT6, CV-CC	11		

DALI BUS POWER SUPPLY & EXTENSION

[→ open Folder D](#)

DALI-2 PS - DALI bus power supply	2	wDALI GR-Transwithter – Receiver PS20	6	DALI 4Net - control of 4 DALI lines	8
DALI-2 Expander - system expansion &	3	wDALI-2 Bluetooth 5 Long Range	6	DALI-2 Display Bus Extension	9
DALI power supply	3	Transwithter – Receiver	6	24V DC Power Supply	9
DALI Proxy	5	wDALI-2 Bluetooth 5 wireless Bridge	7		
DALI Repeater	5	wDALI-2 Extra Long Range wireless Bridge	7		

INTERFACES, TOOLS & GATEWAYS

[→ open Folder E](#)

DALI Cockpit - PC software	2	DALI-2 KNX Room Controller	10	0-10V DALI - converting 0-10V to DALI with	17
short introduction on commission a DALI	2	DALI-2 Room Controller	11	30mA bus supply	17
system	2	DALI Cockpit Mobile - Smartphone App	12	4-20mA to DALI Converter - 24V, with	18
DALI-2 USB 30mA	4	DALI Daylight Bluetooth Interface	13	30mA bus supply	18
DALI USB	4	DALI-2 Audio Interface	13	4-20mA to DALI Converter - 230V, with	18
DALI Flash USB	5	DALI SI, SI-1L	14	30mA bus supply	18
DALI-2 WLAN Cockpit Interface	5	DALI DSI - converting DALI to DSI	14	DALI RM8 / RM16 0-10V	19
DALI 4Net - control of 4 DALI lines	6	DALI Dim2warm - from DT6 to 2x DT6	15	DALI RM8 / RM16 2×0-10V	19
DALI-2 SCI RS232	7	DALI DT8 to DT6 - from DT8-Tc to 2x DT6	15	wDALI RM8 0/1-10V PWM - wireless	20
DALI-2 RS232 PS - with DALI bus supply	7	0-10V DALI - converting 0-10V to DALI with	16	DALI Yeslousie - 230VAC	20
DALI-2 IoT Gateway	8	10mA bus supply	16	DALI 0/1-10V - converting DALI to 0-10V,	21
KNX DALI-2 Gateway	9	0-10V DALI - converting 0-10V to DALI with	17	1-10V or PWM	21
KNX 4 DALI Gateway	10	1, 2 or 3 channels	17		

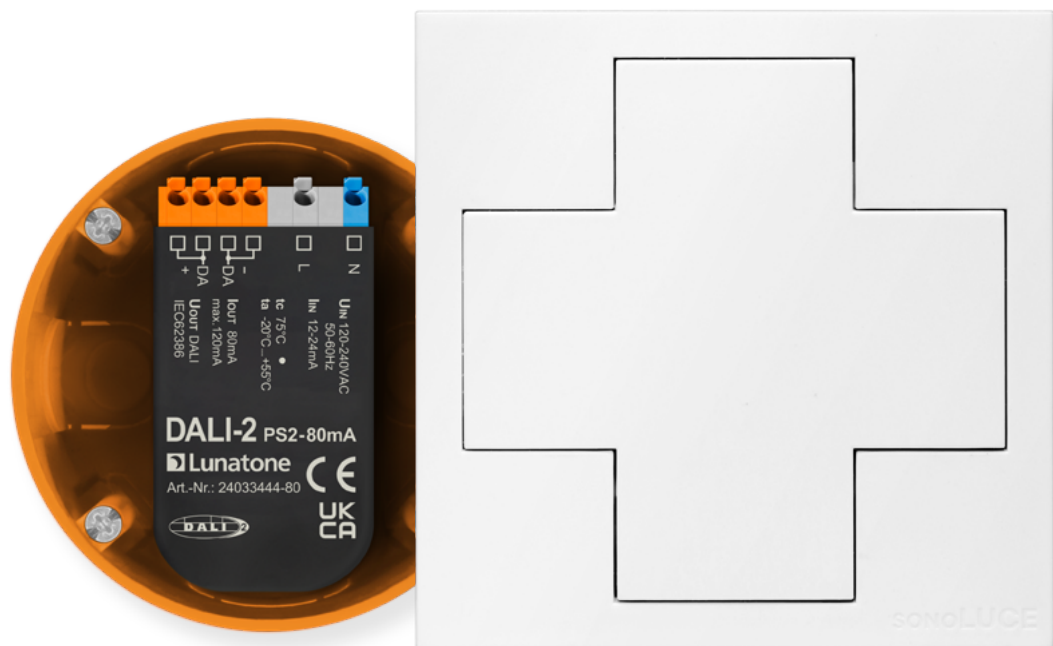

Lunatone

www.lunatone.com

Lunatone Industrielle Elektronik GmbH
Paukerwerkstrasse 5
1210 Vienna, Austria
Tel: +43 1 2026400
E-Mail: office@lunatone.com

Lunatone Lighting GmbH
Hintere Achmühlerstrasse 1,
6850 Dornbirn, Austria
Tel: +43 5572 205050
E-Mail: lighting@lunatone.com